

MPPT

SCC

User's manual



Please connect the battery first, and then connect the solar panel after setting the system parameters. If you do not operate in order, the battery will be damaged

※ Focus	1P-2P	※
Product instructions	3P-18P	
System voltage setting	P8	
Battery type setting	P8	

※ When using lithium batteries, please set the system voltage first, and then set the corresponding battery type (see P8-3.8/3.9).

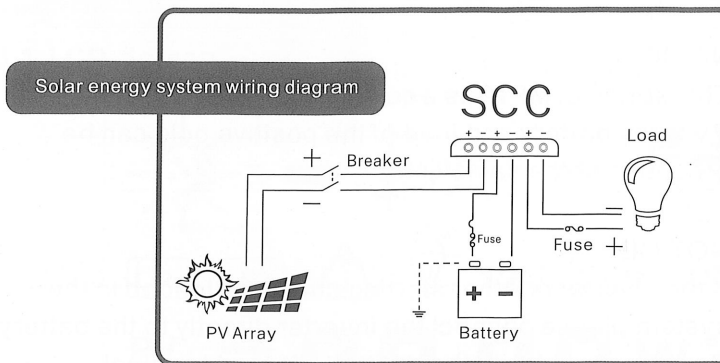

※ Perform the following steps to connect cables and install them ※

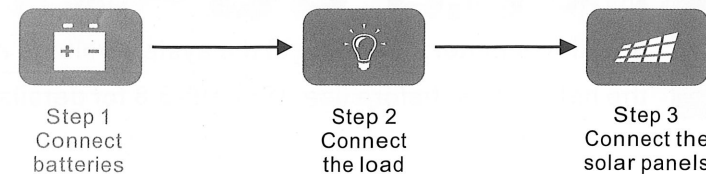

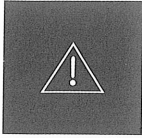

NOTICE:

This series of MPPT is a common positive controller, PV array, battery and load of the positive pole can be grounded at the same time.



NOTICE:

If the inverter or other starting current is loaded in the system, please connect the inverter directly to the battery. Do not connect with the controller's load terminal

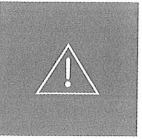

NOTICE:

If a lithium battery is used, set the system voltage and then the battery type before use. (See P8-3.8 for details)





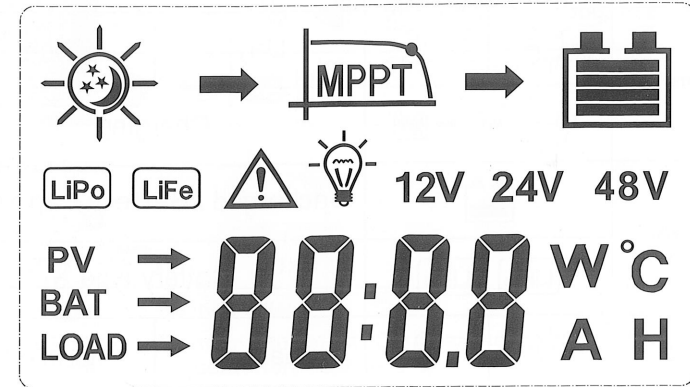



2

3.1 LCD Screen











3

3.2 Status introduce

Item	ICO		Status	
	PV array			Day
		Charging		
Battery			Uncharged / Battery capacity	
			Battery type	
Load			load on	load off

3.3 Button definition

Button meaning	Button pattern				Button function
MENU					Short press to switch down press and hold for 3 seconds to enter the next interface
SET					Short press to switch up Press and hold for 3 seconds to exit without saving

3.4 Boot screen

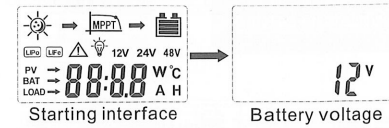

- (1) Starting interface: it is normal to detect LCD when the system is powered on.
- (2) Battery voltage interface: Battery voltage.

Notice: At the first interface long press "MENU" button to enter the secondary interface. It will automatically switch to first interface without doing anything for 15 seconds

3.5 Load switch on/off

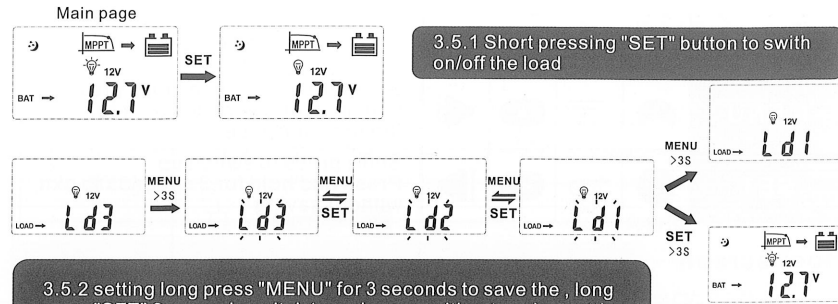

3.6 Main loop pages

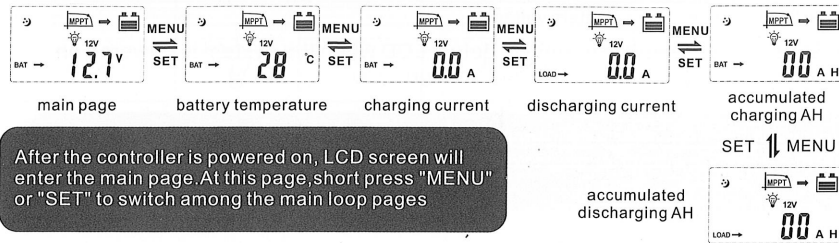

After the controller is powered on, LCD screen will enter the main page. At this page, short press "MENU" or "SET" to switch among the main loop pages

3.7 Setting pages

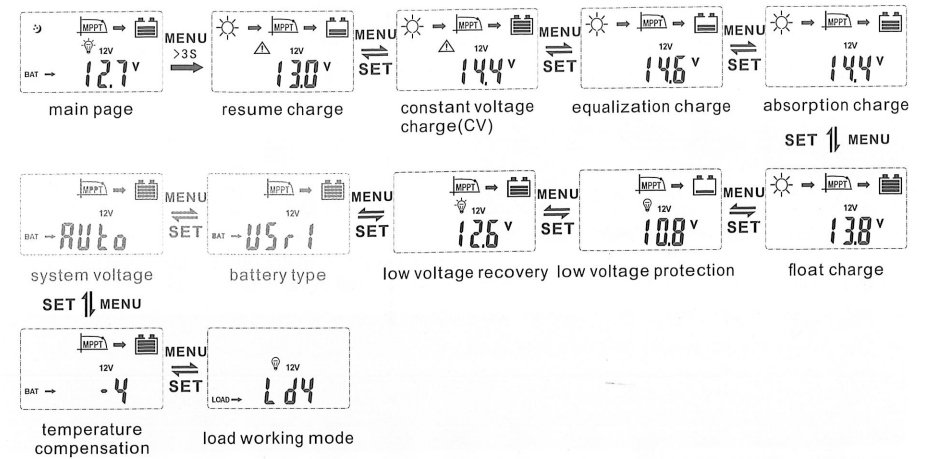

Under the main page, long press "MENU" for 3 seconds to enter the setting page, and then short press "MENU" or "SET" to switch among the setting pages.

3.8 System voltage setting

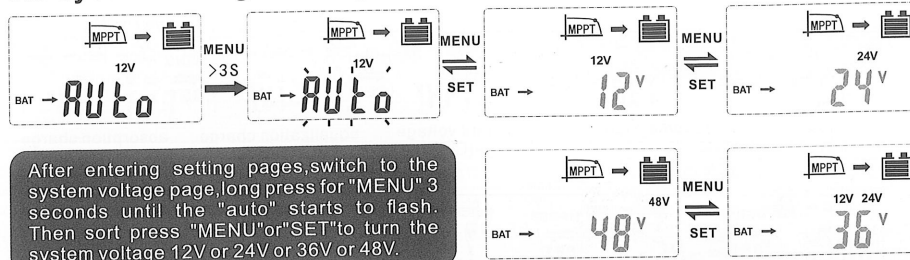

After entering setting pages, switch to the system voltage page, long press for "MENU" 3 seconds until the "auto" starts to flash. Then sort press "MENU" or "SET" to turn the system voltage 12V or 24V or 36V or 48V.

※ 36V is not automatically identified and must be set to a fixed system voltage.

3.9 Battery type

Under the main page, long press "MENU" for 3 seconds to enter the setting page, and then short press "MENU" to switch to the battery type page (user mode 1). After entering battery type page (user mode 1), long press "MENU" for 3 seconds to enter battery type selection pages, short press "MENU" or "SET" to switch among gel battery, sealed battery, flooded battery and lithium batteries.

Under each lithium battery page, long press "MENU" for 3 seconds to enter a program of setting lithium battery's capacity, at this time the parameters on screen will start flashing, keep long pressing "MENU" for 3 seconds, the parameter will become to battery capacity, short press "MENU" or "SET" to set the capacity of the currently connected lithium batteries. After setting the parameters, save the data. Long press for "MENU" 3 seconds to save.

The battery type table displays a graph

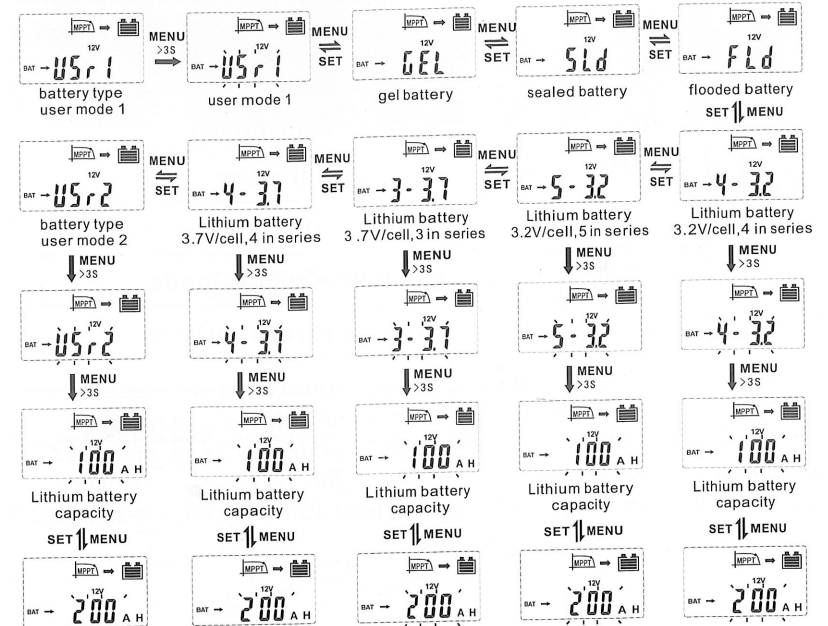

3.10 Load working mode

The controller default load working 24 hours, and there are 4 load working modes for selection:

code	Code explanation
Ld1 (LD1)	regular mode
Ld2 (LD2)	light control mode
Ld3 (LD3)	light & time control mode
Ld4 (LD4)	Reverse light control mode

LD1: The load works normally and can be turned on or off manually.

LD2: The load automatically opens at dark and closes at dawn.

LD3: Load working hours after dark, load working hours before dawn. (automatically identify dark and light according to local environment)

LD4: Load automatically open at dawn, load automatically close at dark.

10



When selecting 'LD3' this mode, set the length of the two work (hours). If you need to test, you can choose 'T-on', at this time the length of the unit hour changes into minutes. If you do not need to test, you can choose 'T-of' to close the test. Working hours restored to hours.

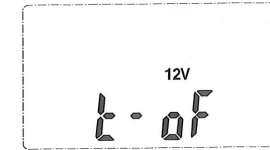
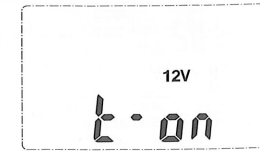

3.11 PV voltage page

Long press "SET" for 3 seconds to switch between the main page and PV voltage page.

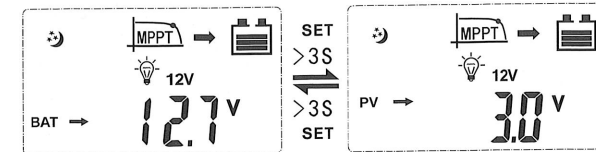

11

3.12 Setting of equalization charging duration

After switching to the equalization charge page from the main page, Long press "MENU" for 3 seconds when the parameter starts to flash, keep pressing it for 3 seconds to turn the page to equalization charging duration setting page, short press "MENU" or "SET" to increase or decrease the time.

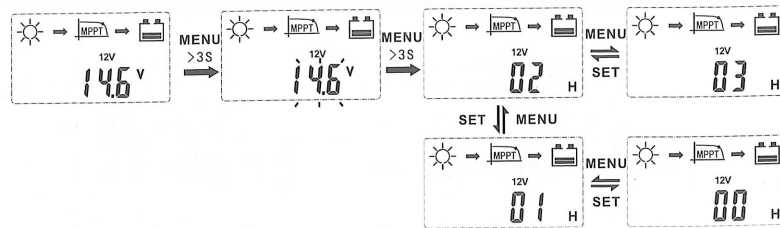

3.13 Setting of absorption charging duration

After switching to the absorption charge page from the main page, Long press "MENU" for 3 seconds when the parameter starts to flash, keep pressing it for 3 seconds to turn the page to absorption charging duration setting page, short press "MENU" or "SET" to increase or decrease the time.

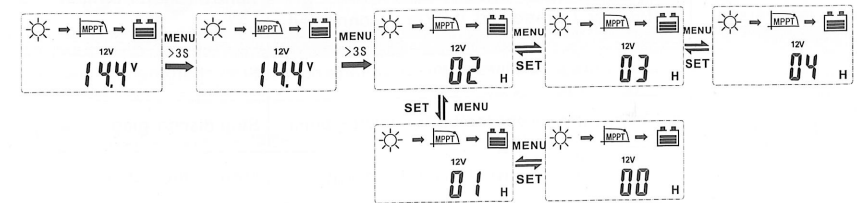

4. Protection Function

Protection	Condition	Status
Solar panel reversed	Solar panel can be reversed if battery is not connected	Controller isn't broken
Battery is reversed	Battery can be reserved if PV is unconnected	
Battery over-voltage	Battery voltage reaches the over-voltage point	Stop charging and discharging
Battery over-discharge	Battery voltage drops the under-voltage point	Stop discharging
Over-load	The load current is over the rated current	Turn off the output

5. Fault Management

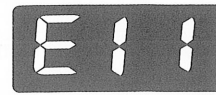

- ① E Stands for 'Error'
- ② | Indicates the number of faults, which may report multiple faults '2' or '3' at the same time...
- ③ | Represents the fault code '1 1'

Error code	Cause	Correction
E11	Battery over discharge	The load will stop automatically and recover when battery voltage reaches 12.6V (LVR)
E12	Battery over voltage	Make sure the settled value of high voltage disconnection voltage is over battery voltage and reconnect PV array.
E13	Over load	Reduce load or check load connection
E15	Controller overheating	The controller will restart after it cools down
E16	Input voltage of solar panel is too high	Check voltage of solar panel and reduce quantities of solar panel in series
E17	Controller will restart after setting system voltage	No operation

Other faults :

- 1-When the sun is sufficient, the PV has no state, please check whether the PV terminal wiring is correct, or whether the wiring is firm ;
- 2-All wiring is correct, but there are two reasons why the screen does not light up :
(1) battery voltage < 8V, (2) PV voltage is lower than the battery voltage.

6. Technical Data

Rated charge current	10A	20A	30A	30A	40A	50A	60A	80A	100A	
Input										
Maximum input power	12V	130W	260W	390W	390W	520W	650W	780W	1040W	1300W
	24V	260W	520W	780W	780W	1040W	1300W	1560W	2080W	2600W
	36V	/	/	/	(1170W)	(1560W)	(1950W)	(2340W)	(3102W)	(3900W)
	48V	/	/	/	(1560W)	(2080W)	(2600W)	(3120W)	(4160W)	(5200W)
System rated voltage	12V/24V Auto.			12V/24V or 12V/24V/36/48V Auto.						
Max open voltage of solar panel	<60V (24V)	<60V (24V)	<75V (24V)	<100V(12V/24V) <150V(12V/24V/36V/48V)						
Output										
Rated Discharge Current	10A	20A	20A	20A	30A		40A			
Battery type	User default, Sealed, Flooded, GEL, LiFePO4, Li(NiCoMn)O2.									
Equalized charging voltage ✕	Maintenance-free lead-acid battery : 14.6V, GEL:No;Lead-acid Flooded battery: 14.8V			Duration: 2hours						
Absorption charging voltage ✕	Maintenance-free lead-acid battery : 14.4V, GEL:14.2V ;Lead-acid Flooded battery: 14.6V			Duration: 2hours						
Float charging voltage ✕	Maintenance-free lead-acid battery, GEL, lead-acid Flooded battery : 13.8V									

16

LVR ✕	Maintenance-free lead-acid battery, GEL, lead-acid Flooded battery : 12.6V			
LVD ✕	Maintenance-free lead-acid battery, GEL, lead-acid Flooded battery : 10.8V			
Static loss	24V(<50mA)/48V(<35mA)			
HVD	12V Lead acid battery	24V Lead acid battery	36V Lead acid battery	48V Lead acid battery
	16V	32V	48V	64V
Light control voltage	5V/10V/15V/20V			
Temperature compensation coefficient	-4mV/°C/2V(25°C)			
Discharge loop voltage drop	≤0.2V			
LCD temperature	-20°C ~ +70 °C			
Operating temperature	-10~+50°C			
Storage temperature	-30 ~ +80 °C			
Working humidity	≤90%, No condensation			
Protection class	IP30			
Grounded type	Positive grounded			
Aperture for installation	Φ5mm			
✕	The preceding parameters are 12V system and the temperature is 25°C.24V system 2x; 36V system 3x;48V system 4x.			

17